



PACKAGING

2015-2016 PRODUCT CATALOG



Promotional Packaging - Corrugated Packaging - B2B Packaging - Boxes & Mailers
High Definition Printing - Digital Solutions - UV Finishing & More



Envision3 is a single source marketing services provider and one of the top 300 largest UV printing and mailing manufacturers in the country. We understand that the integrity of your brand and the customers you serve are everything. Envision3's packaging solutions were created to help you present your products and services in the very best light possible.



MARKETING



PRINTING



PACKAGING



MAILING

If you have any questions or further needs after viewing this catalog, please contact your account rep. We look forward to serving you!

CONTENTS

1. Promotional Packaging
2. Boxes & Mailers
4. Specialty Packaging
5. Folding Cartons
6. Non-Reinforced Folders
7. Reinforced & Box Pocket Folders
8. Stitched & Stepped Inserts
8. Mid-size & Mini Folders
9. Legal Folders
9. 3-Panel Folders
10. Marketing & Printing Services
11. Packaging & Mailing Services
12. Key Card Holders
12. Slits
13. Report/Tax Covers
14. Tang Products & Page Pockets
14. Certificate Holders & Tabs
15. Laminated Paperboard Binders
15. Totes
16. Paperboard Mailers & Doc. Holders
17. Easel & Literature Holders
18. Slip Cases
18. CD/DVD Packaging
19. Expander Products
20. Custom Packaging
21. Finishing and more



PROMOTIONAL PACKAGING

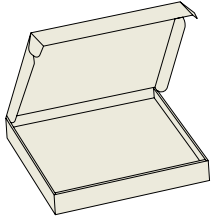

M-2000

6-1/2 x 4-1/2 x 1-1/4
Small Promotional Box with
1/2" tray. E-Flute Corrugate.
Ships flat.

**Prices include a custom die
cut tray fit to your product!**

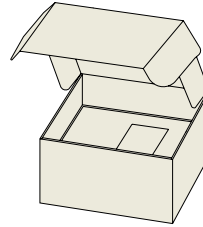

M-2004

8-1/2 x 5-1/2 x 4-1/2
Coffee Mug Mailer with tray.
E-Flute Corrugate.
Ships flat.

**Prices include a custom die
cut tray fit to your product!**

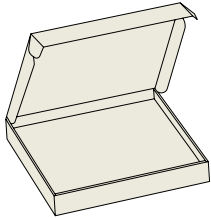

M-2001

9-1/2 x 6-1/4 x 2
Medium Promotional
Box with 1" tray.
E-Flute Corrugate.
Ships flat.

**Prices include a custom die
cut tray fit to your product!**

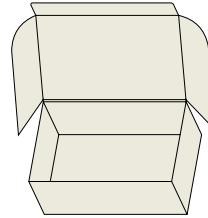

M-2005

10-3/4 x 7 x 4
Donut Box.
Ships flat.
14 Pt. C/1/S.

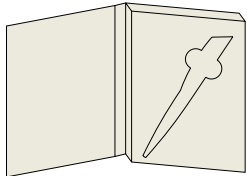

M-2002

4-1/4 x 5-1/2 x 1/2
2-Panel Pen Box
with Styrene Cavity.

Great
For USB
Drives!

**Prices include a custom die
cut tray fit to your product!**

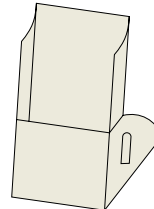

M-2007

4 x 7 x 1-1/2
Literature Holder.
E-Flute Corrugate.
Ships flat.

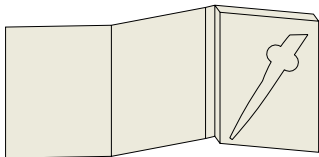

M-2003

4-1/4 x 5-1/2 x 1/2
3-Panel Pen Box
with Styrene Cavity.

**Prices include a custom die
cut tray fit to your product!**

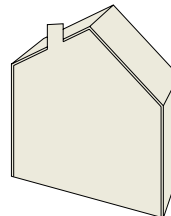

M-2008

7 x 6-3/8 x 1-5/8
House Box.
E-Flute Corrugate.
Ships flat.

Film lamination is recommended on all corrugated projects, particularly those with heavy ink coverage in order to prevent cracking. In the event clients choose to proceed without lamination, the plant will not be held responsible for cracking that occurs on non-laminated jobs.

BOXES & MAILERS

For convenience, boxes and mailers assemble without tape or glue and ship flat. Four color process is standard when using high quality offset printing onto a litho label that is then mounted to a corrugated board. Packaging jobs can have a white or kraft inside and have no restrictions on placement of artwork. Digital, short run solutions are available too.

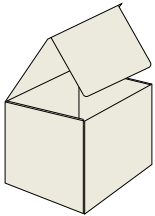

M-2010

4 x 4 x 4
Mug Box. All sides can be imprinted.
Copy must remain 1/4" away from
scores and edges.

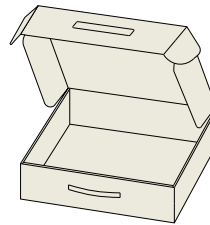

M-2012

12-1/8 x 9-1/4 x 3
Box with handle.
All sides can be imprinted.
Copy must remain 1/4" away from
scores and edges.

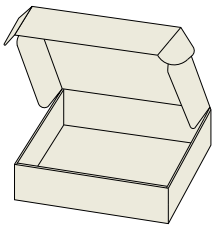

M-2011

9 x 6-1/2 x 2-3/4
Mailer. All sides can be imprinted.
Copy must remain 1/4" away from
scores and edges.

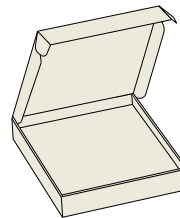

M-2013

12 x 12 x 2
Pizza Box. All sides can be imprinted.
Copy must remain 1/4" away from
scores and edges.

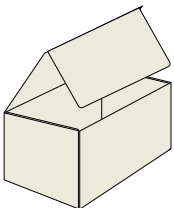

M-2014

5 x 3 x 3
Mailer. All sides can be imprinted.
Copy must remain 1/4" away from
scores and edges.

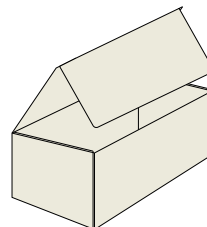

M-2015

8 x 4 x 3
Mailer. All sides can be imprinted.
Copy must remain 1/4" away from
scores and edges.

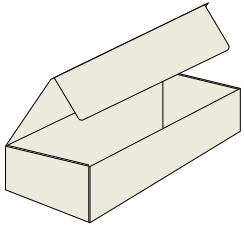

M-2016

12 x 3-1/2 x 3
Mailer. All sides can be imprinted.
Copy must remain 1/4" away from
scores and edges.

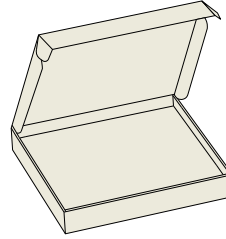

M-2019

11-1/8 x 8-3/4 x 3
Mailer. All sides can be imprinted.
Copy must remain 1/4" away from
scores and edges.

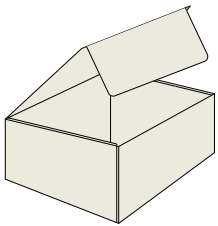

M-2017

6 x 2-1/2 x 2-3/8
Mailer. All sides can be imprinted.
Copy must remain 1/4" away from
scores and edges.

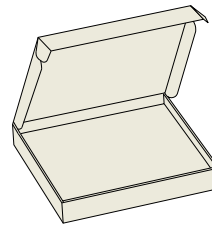

M-2020

12 x 11 x 3
Mailer. All sides can be imprinted.
Copy must remain 1/4" away from
scores and edges.

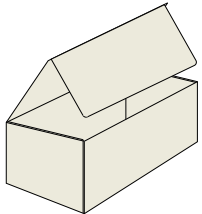

M-2018

7 x 5 x 4
Mailer. All sides can be imprinted.
Copy must remain 1/4" away from
scores and edges.

Film lamination is recommended on all corrugated projects, particularly those with heavy ink coverage in order to prevent cracking. In the event clients choose to proceed without lamination, the plant will not be held responsible for cracking that occurs on non-laminated jobs.

CUSTOM BOXES

We specialize in custom boxes. Our design and product development group will work with you every step of the way, helping you select the products that best meet your creative and budget objectives. We can provide CAD-designed prototypes made to your specifications, enabling you to plan each project with greater precision.

See More Custom Packaging on Page 20.



SPECIALTY PACKAGING

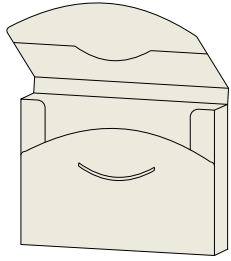

M-2022
9 x 12 x 1/2
E-Flute Tote

M-2023
9 x 12 x 1
E-Flute Tote
Ships flat

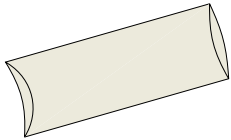

M-2040
6 x 4-1/2 x 1-1/2
Pillow Pack. Both sides can be imprinted. 1 and 2 color prices based on light to medium ink coverage. 14 Pt. C/1/S.

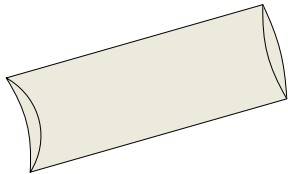

M-2041
10 x 5 x 2
Pillow Pack. 1 and 2 color prices based on light to medium ink coverage. 14 Pt. C/1/S.

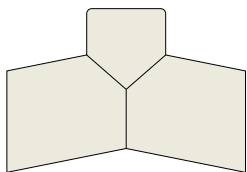

M-2042
4-1/4 x 5-1/2
Pop-Up Mailer. Add your message or gift card to pop up area. Both sides can be printed. Ships flat. 100# Gloss Cover.

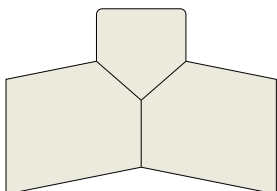

M-2043
5 x 7
Custom Pop-Up Mailer. Customize the shape of the pop-up area. Prices include custom die cutting die. Both sides can be printed. Ships flat. 100# Gloss Cover.

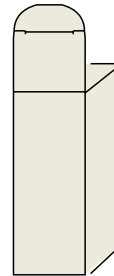

M-2044
3-Pack Golf Ball Sleeve.
Ships flat. 14 Pt. C/1/S.

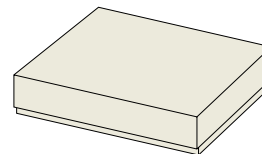

M-2045
Dozen Golf Ball Box
Ships flat. 18 Pt. C/1/S.

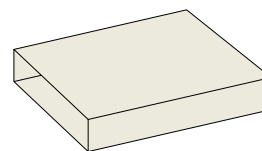

M-2046
Dozen Golf Ball Sleeve
Ships flat. 14 Pt. C/1/S.

Envision3 designs and manufactures folding cartons in many styles and sizes. Our design team will help you choose the correct substrate, size and configuration to support your product.

Commonly used styles include: straight and reverse tuck closures, auto bottom and two piece cartons. Consult your sales representative for samples and prototypes.

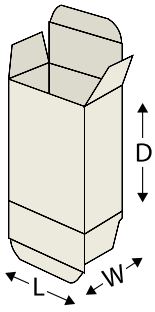

MEASURE A FOLDING CARTON BY THE DIMENSIONS: L X W X D

L-Length: The dimension across the box opening from left to right if box is facing you and the top facing up.

W-Width: The dimension from the front panel to the back panel.

D-Depth: The dimension from the top (opening side) to the bottom (opening side) showing how deep the carton is.

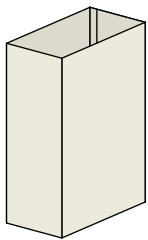

Sleeve

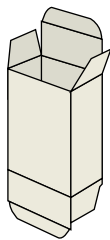

Reverse Tuck

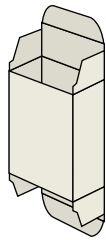

Straight Tuck

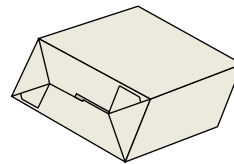

Auto Bottom

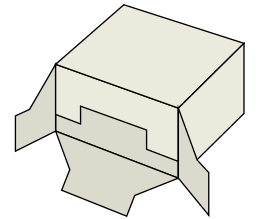

1-2-3 Bottom

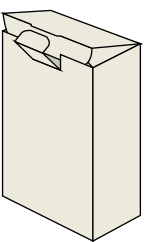

Tuck & Tongue

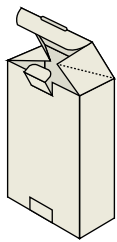

Bellows (Gusset) Tuck

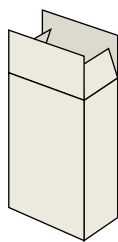

Full Overlap Seal End

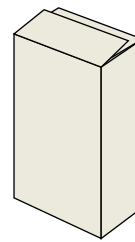

Partial Overlap Seal

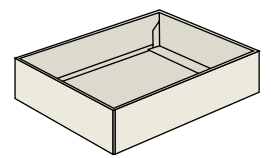

Simplex Tray

NON-REINFORCED FOLDERS

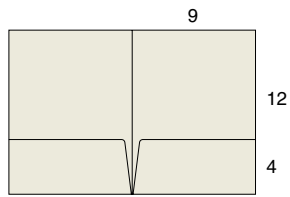

M-100

9 x 12
Folder with (2) 4" glued pockets.

M-101

9 x 12
Folder with (2) 3" glued pockets (not pictured).

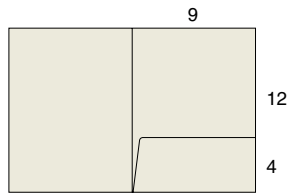

M-102

9 x 12
Folder with (1) 4" right glued pocket.

M-103

9 x 12
Folder with (1) 3" right glued pocket (not pictured).

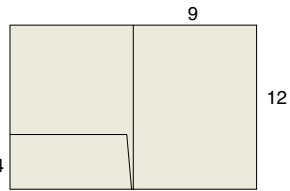

M-104

9 x 12
Folder with (1) 4" left glued pocket.

M-105

9 x 12
Folder with (1) 3" left glued pocket (not pictured).

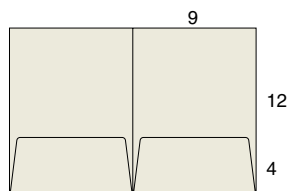

M-106

9 x 12
Folder with (2) 4" unglued flaps.

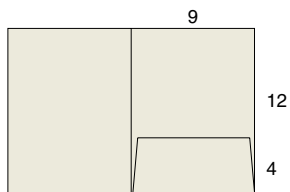

M-107

9 x 12
Folder with (1) 4" unglued right flap.

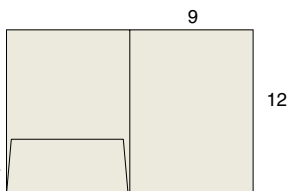

M-108

9 x 12
Folder with (1) 4" unglued left flap.

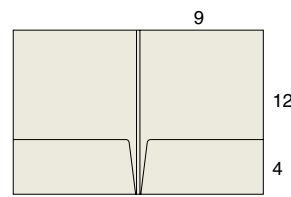

M-109

9 x 12
Folder with (2) 4" glued pockets and 1/4" spine.

M-110

9 x 12
Folder with (2) 4" glued pockets and 1/2" spine (not pictured)

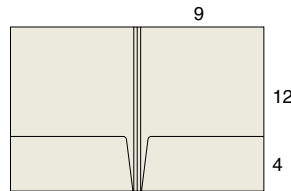

M-111

9 x 12
Folder with (2) 4" glued pockets and triple score spine.

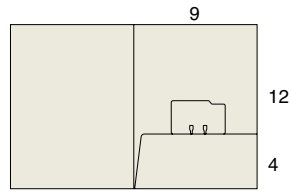

M-112

9 x 12
Folder with (1) 4" glued pocket and file card.

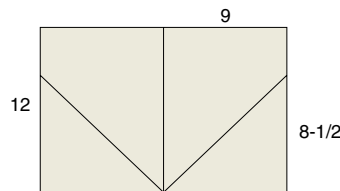

M-113

9 x 12
Folder with (2) 8-1/2" glued angled pockets.

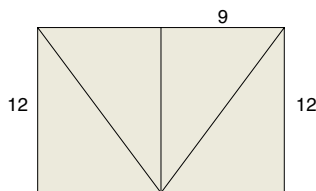

M-114

9 x 12
Folder with (2) 12" glued angled pockets.

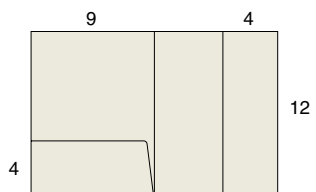

M-115

9 x 12
Folder with (1) 4" horizontal pocket and (1) 4" vertical pocket.

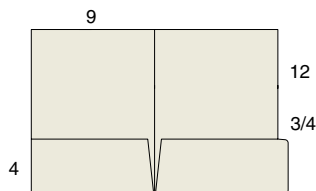

M-129

9 x 12
Folder with (2) 4" glued pockets and (1) 3/4" file tab extension.

REINFORCED FOLDERS & BOX POCKET FOLDERS

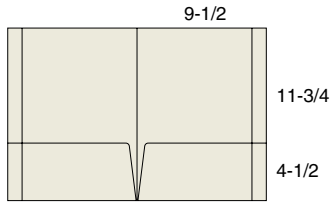

M-200
9-1/2 x 11-3/4
Folder with (2) 4-1/2" glued pockets.

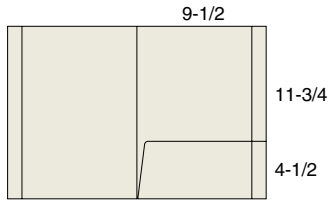

M-201
9-1/2 x 11-3/4
Folder with (1) 4-1/2" right glued pocket.

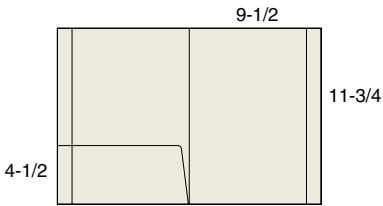

M-202
9-1/2 x 11-3/4
Folder with (1) 4-1/2" left glued pocket.

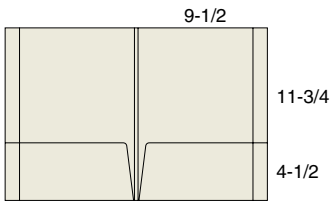

M-203
9-1/2 x 11-3/4
Folder with (2) 4-1/2" glued pockets and 1/4" spine.

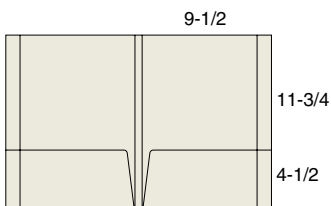

M-204
9-1/2 x 11-3/4
Folder with (2) 4-1/2" glued pockets and 1/2" spine.

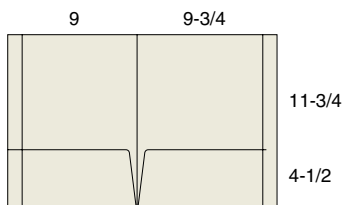

M-205
9-3/4 x 11-3/4
Folder with (2) 4-1/2" glued pockets and extended tab.

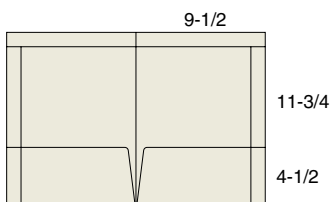

M-206
9-1/2 x 11-3/4
Folder with (2) 4-1/2" glued pockets and reinforced top.

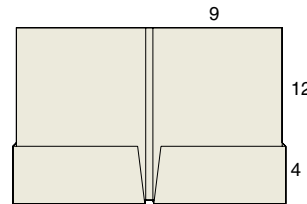

M-300
9 x 12
Folder with (2) 4" x 1/4" box pockets and 9/16" spine.

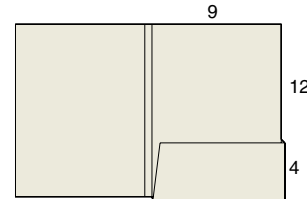

M-301
9 x 12
Folder with (1) 4" x 1/4" right box pocket and 5/16" spine.

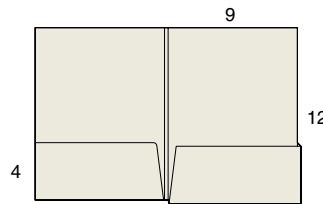

M-302
9 x 12
Folder with (1) 4" left flat glued pocket and (1) 4" x 1/4" right box pocket and 5/16" spine.

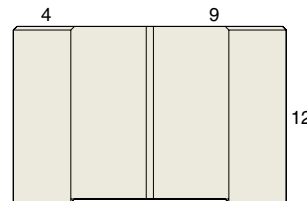

M-303
9 x 12
Folder with (2) vertical 4" x 1/4" box pockets and 9/16" spine.

M-304
Available with 5/16" spine (not pictured).

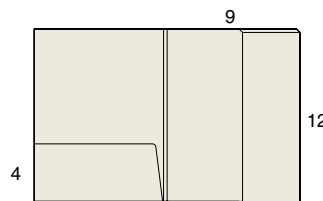

M-305
9 x 12
Folder with (1) 4" left flat glued pocket and (1) 4" x 1/4" right vertical box pocket and 5/16" spine.

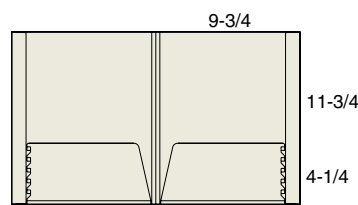

M-306
9-3/4 x 11-3/4
Folder with (2) 4-1/4" x 1/4" expandable zipper pockets and 9/16" triple score spine (Same pricing as M-200).

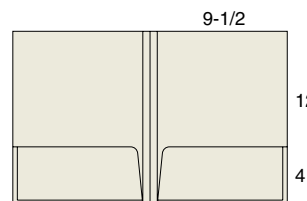

M-307
9.5 x 12
Expandable Folder with (2) 4" glued pockets

STITCHED & STEPPED INSERTS

Stitched Inserts

4, 8, 12, and 16 Page Stitched Inserts Available. Stitched Inserts are available with folder styles M-100 through M-108 only. (see pg. 6)

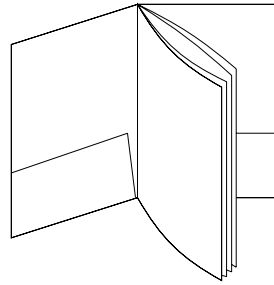

Stepped Inserts

Stepped Inserts are available to fit all size folders and can be produced on the stock of your choice. Inserts can be printed on one or two sides and can utilize special die cutting or film lamination. Please call for pricing.

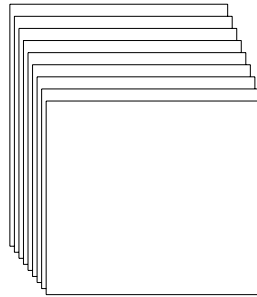

MID-SIZE & MINI FOLDERS

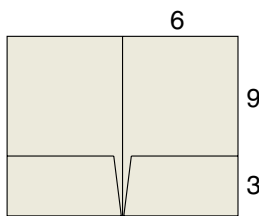

M-119
6 x 9
Mid-size Folder with
(2) 3" glued pockets.

M-120
6 x 9
Mid-size Folder with (1) 3" right
glued pocket (not pictured).

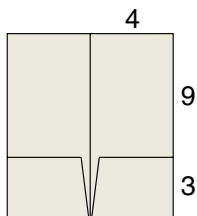

M-121
4 x 9
Mini Folder with (2) 3"
glued pockets.

M-122
4 x 9
Mini Folder with (1) 3" right
glued pocket (not pictured).



EXPANDER

*Need a little extra capacity?
Try one of our Expander Folders
at no additional cost!
See page 19 for details.*

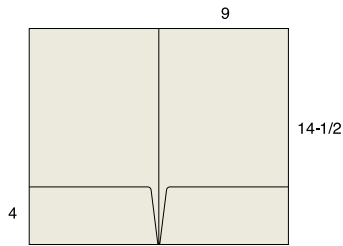

M-116
9 x 14-1/2
Legal Size Folder with
(2) 4" glued pockets.

M-117
9 x 14-1/2
Legal Size Folder with
(2) 3" glued pockets
(not pictured).

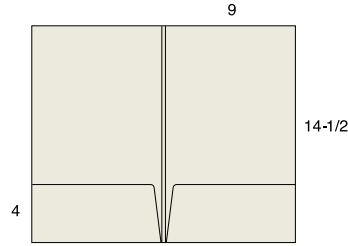

M-118
9 x 14-1/2
Legal Size Folder with
(2) 4" glued pockets
and 1/4" spine.

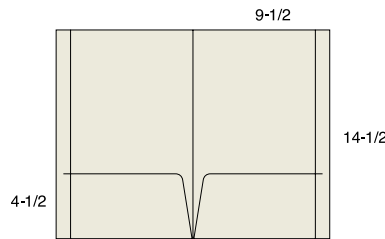

M-207
9-1/2 x 14-1/2
Folder with (2) 4-1/2"
glued pockets.

3-PANEL FOLDERS

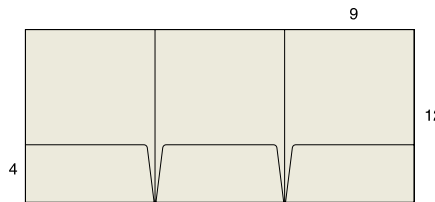

M-400
9 x 12
Folder with (2) 4" outside
glued pockets and (1)
4" center unglued flap.

M-401 9 x 12
Folder with (1) 4"
center unglued flap.

M-404 9 x 12
Folder with (1) 4"
left glued pocket.

M-402 9 x 12
Folder with (2) 4"
outside glued pockets.

M-405 9 x 12
Folder with (1) 4"
center unglued flap
and (1) 4" right
glued pocket.

M-403 9 x 12
Folder with (1) 4"
right glued pocket.

M-406 9 x 12
Folder with (1) 4"
left glued pocket
and (1) 4" center
unglued flap.

MARKETING. PRINTING. MAILING.



MARKETING

Resonance, it happens when the strength and clarity of your creative fits the quality of the products and services you sell. Found your identity yet? Let's find it together.

- ✓ Integrated Campaigns
- ✓ Branding & Identity
- ✓ Marketing Strategy
- ✓ Copy Writing
- ✓ Web Development
- ✓ Graphic Design
- ✓ Personalized URL's
- ✓ Mailing Solutions
- ✓ Email Marketing



PRINTING

The printing process is equal parts manufacturing, art and science. Achieve unsurpassed image detail and electrifying color with industry leading Co-Res screening technology.

- ✓ 6C UV Offset Printing
- ✓ HP Indigo Digital Printing
- ✓ Personalization/VDP
- ✓ Prepress Services
- ✓ Web-to-Print
- ✓ Packaging
- ✓ Kitting & Fulfillment
- ✓ Bindery & Finishing
- ✓ UV Finishing & More



PACKAGING. ALL UNDER ONE ROOF.



PACKAGING

Strong first impressions start with high quality printing, exceptional finishing and the perfect balance of structural and aesthetic design. From prototype to finished product.

- ✓ High Quality Printing
- ✓ Retail Packaging
- ✓ Custom Packaging
- ✓ P.O.P. Displays
- ✓ B2B Packaging
- ✓ Promotional Packaging
- ✓ Corrugated Packaging
- ✓ Digital Solutions
- ✓ UV Finishing & More



MAILING

Can we deliver? 1,000,000 pieces mailed monthly says so. Combine the right message with the right mail mode for stronger impressions, higher response rates and bigger yields.

- ✓ Data List Processing
- ✓ Data List Purchasing
- ✓ Data Management
- ✓ Multi-Piece Match
- ✓ Automated Insertion
- ✓ Inkjet Personalization
- ✓ Co-mailing & Co-Mingling
- ✓ Fulfillment
- ✓ Drop Shipping



KEY CARD HOLDERS

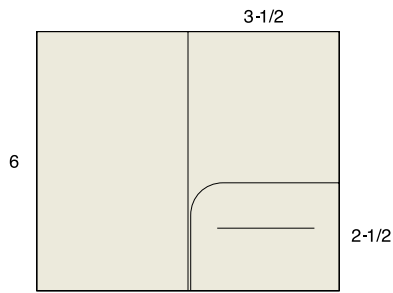

M-1100

3-1/2 x 6
Folder with (1)
2-1/2" pocket.

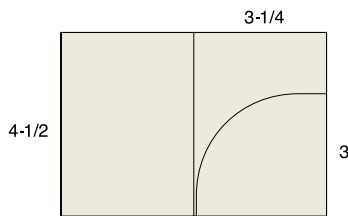

M-1101

3-1/4 x 4-1/2
Folder with (1)
3" pocket.



SLITS

BUSINESS CARD SLITS

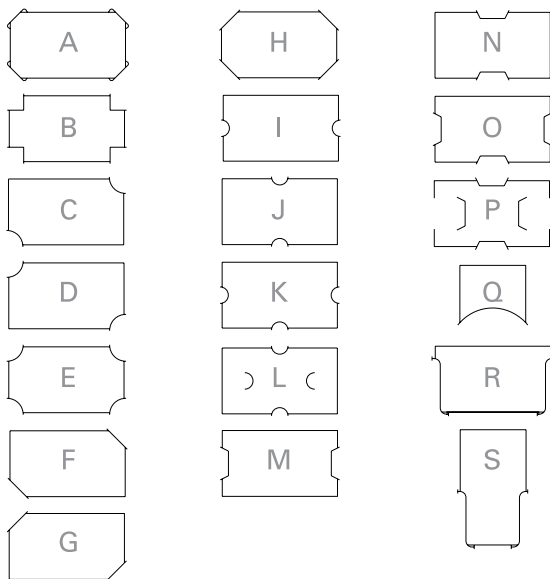

DISK & BROCHURE SLITS

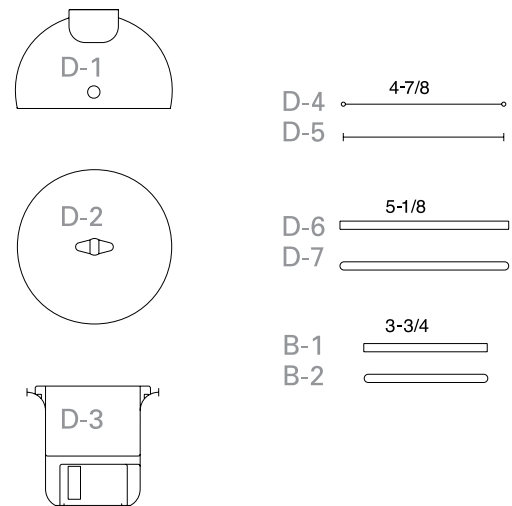

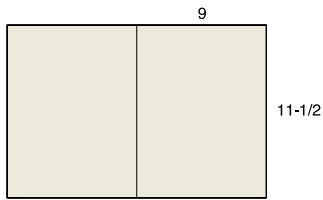

M-500
9 x 11-1/2
One piece report cover.

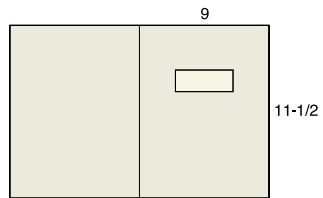

M-501
9 x 11-1/2
One piece report cover with window.

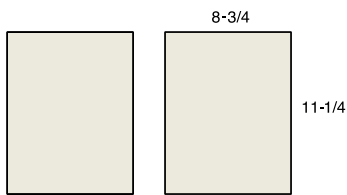

M-502
8-3/4 x 11-1/4
Two piece report cover.

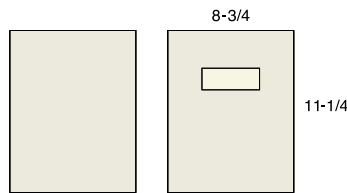

M-503
8-3/4 x 11-1/4
Two piece report cover with window.

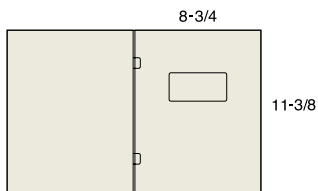

M-504
8-3/4 x 11-3/8
One piece – side stitch report cover with window.

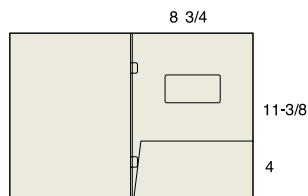

M-505
8-3/4 x 11-3/8
One piece – side stitch report cover with (1) 4" glued pocket and window.



**Round
Corners**

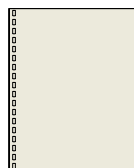

**Comb
Binding
Punch**

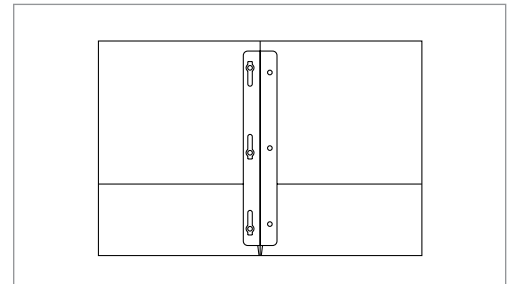

Spine attachments can be stitched into the center of M-500 and M-501. They are 14 pt. C1S white stock and come standard with (3) 3/4" fasteners and eyelets. Spine attachments require additional production time.

Note: please indicate if your order requires spine attachments.



TANG PRODUCTS

PAGE POCKETS

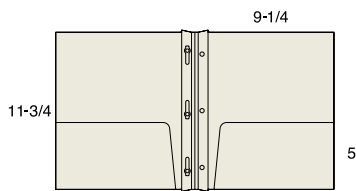

M-800
Tang Folder
with (2) 5"
glued pockets

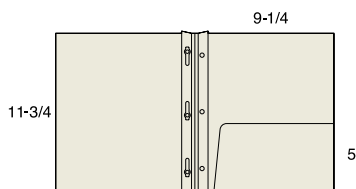

M-801
Tang Folder
with (1) 5"
glued pocket



M-802
Tang Cover
without pockets

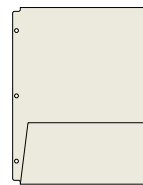

M-1300
9 x 11-1/2
Page Pocket
12 Pt. C/1/S.

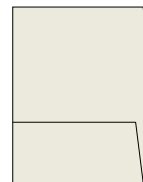

M-1301
9 x 11-1/2
Page Pocket
12 Pt. C/1/S.

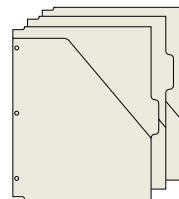

M-1302
9 x 11-1/2
3 Tabbed
Page Pockets

CERTIFICATE HOLDERS

TABS

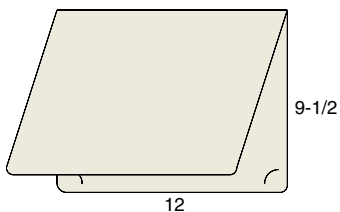

M-1250
9-1/2 x 12
Certificate Holder.
Holds 8-1/2" x 11" sheet.

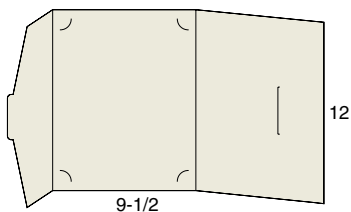

M-1251
9-1/2 x 12
Certificate Holder.
Wrap around cover with
self-forming easel.

What enhances a binder more than tabs? We make them in a variety of materials and colors. Stock and custom sizes are available with or without mylar reinforcing. Please call for pricing.



LAMINATED PAPERBOARD BINDERS

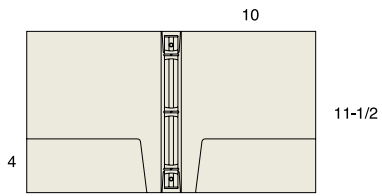

M-700

Binder with (2)
4" glued pockets
(1/2" ring size shown).

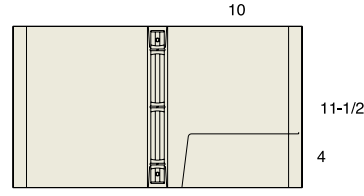

M-703

Binder with (1)
4" glued pocket and
reinforced edges
(1/2" ring size shown).

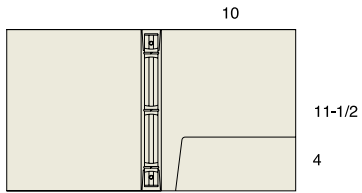

M-701

Binder with (1)
4" glued pocket
(1/2" ring size shown).

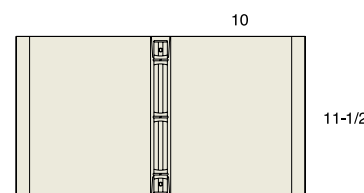

M-704

Binder without pockets
with reinforced edges
(1/2" ring size shown).

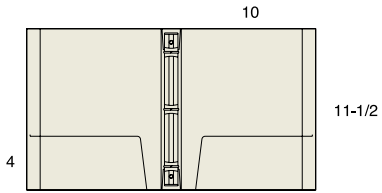

M-702

Binder with (2)
4" glued pockets and
reinforced edges
(1/2" ring size shown).



TOTES

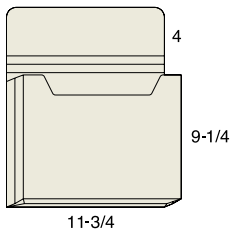

M-1001

9-1/4 x 11-3/4
Expandable Tote with 4" flap.
Available in 1-1/4", 1-1/2", or
2" capacity. 14 Pt. C/1/S.

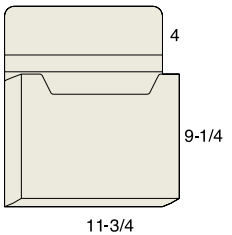

M-1003

9-1/4 x 11-3/4
Fixed Capacity Tote with 4" flap.
18 Pt. C/1/S.

Totes are available in 5/8", 1", 1-1/2" or 2"
capacity and come standard with 1 set of
Velcro dots. Totes ship fully assembled.

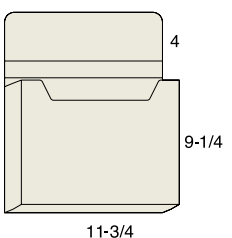

M-1005

9-1/4 x 11-3/4
Fixed Capacity Locking Tote with 4" flap.
Ships flat. 18Pt. C/1/S.

Totes are available in 1" capacity and come
standard with 1 set of Velcro dots.



PAPERBOARD MAILERS & DOCUMENT FOLDERS

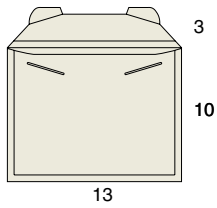

X-901

10 x 13
Expandable Mailer with
3" flap and tuck closure
(5/8" Capacity).

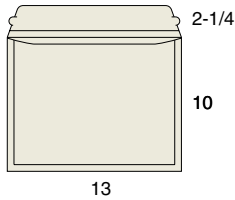

X-902

10 x 13
Expandable Mailer
with 2-1/4" flap and nylon
tear strip (5/8" Capacity).

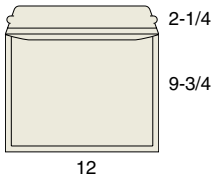

X-916

9-3/4 x 12
Expandable Mailer
with 2-1/4" flap and nylon
tear strip (5/8" Capacity).

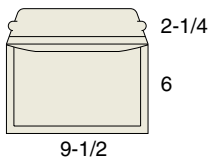

X-917

6 x 9-1/2
Expandable Mailer
with 2-1/4" flap and nylon
tear strip (1/2" Capacity).

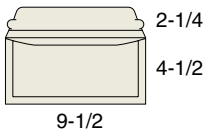

X-918

4-1/2 x 9-1/2
Expandable Mailer
with 2-1/4" flap and nylon
tear strip (3/8" Capacity).

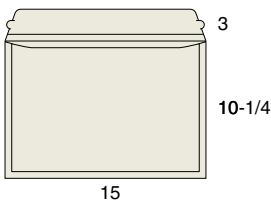

X-919

10-1/4 x 15
Expandable Mailer
with 3" flap and
nylon tear strip
(5/8" Capacity).

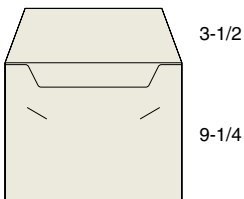

M-1000

9-1/4 x 11-3/4
Flat Mailer with 3-1/2" flap.
14 Pt. C/1/S.

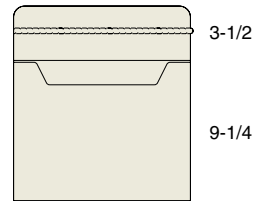

M-1002

9-1/4 x 11-3/4
Flat Mailer with 3-1/2" flap
and nylon tear strip.
14 Pt. C/1/S.

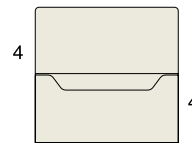

M-1004

4 x 9
Document Folder with
4" flap. 12 Pt. C/1/S.

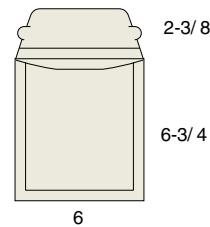

X-930

6 x 6-3/4
Expandable CD/DVD
Mailer with 2-3/8" flap
and nylon tear strip.

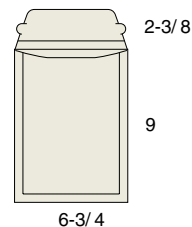

X-931

6-3/4 x 9
Expandable CD/DVD
Mailer with 2-3/8" flap
and nylon tear strip.

EASEL & LITERATURE HOLDERS

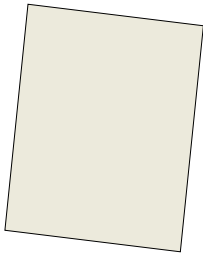

M-2070

8 x 10
Pop-Up Easel.
Ships flat.
18 Pt. C/1/S with
Film Lamination.

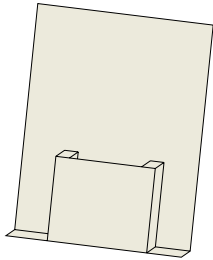

M-2071

8 x 10
Pop-Up Easel with
built in 3-3/4 x 4-1/4"
push up pocket.
Ships flat.
18 Pt. C/1/S with
Film Lamination.

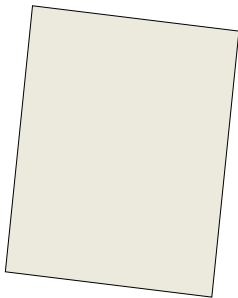

M-2072

9 x 12
Pop-Up Easel.
Ships flat.
18 Pt. C/1/S with
Film Lamination.

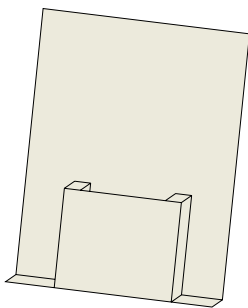

M-2073

9 x 12
Pop-Up Easel with
built in 3-3/4 x 4-1/4"
push up pocket.
Ships flat.
18 Pt C/1/S with
Film Lamination.

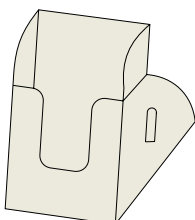

M-2074

2-3/4 x 3-1/2 x 1-1/2
Pocket schedule holder.
Ships flat.
18 Pt. C/1/S.

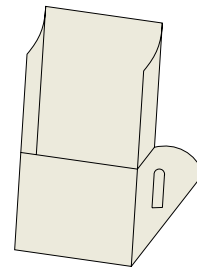

M-2075

4 x 7 x 1-1/2
Literature holder.
Ships flat.
18 Pt. C/1/S.

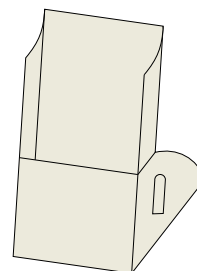

M-2007

4 x 7 x 1-1/2
Literature holder.
Ships flat. E-Flute
Corrugated board.

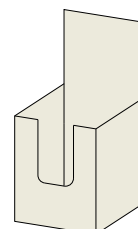

M-2076

2-3/4 x 3-1/2 x 5
Pocket schedule
display box. Top flap
forms a header panel
when open. Ships flat.
14 Pt. C/1/S.

SLIP CASES

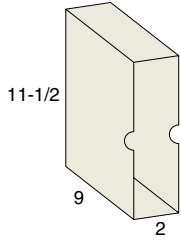

M-2080
2" Slip Case with lock tab construction. 24 Pt. C/1/S with Gloss film lamination. Ships flat.

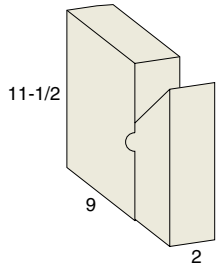

M-2081
2" Slip Case / Slant Case Set with lock tab construction. 24 Pt. C/1/S with Gloss film lamination. Ships flat.

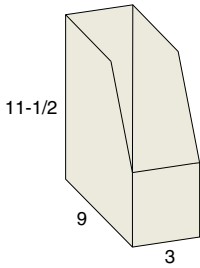

M-2083
3" Corrugated Slant Case with lock tab construction. E-Flute corrugated board. Ships flat on skids.

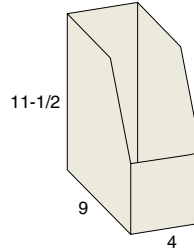

M-2084
4" Corrugated Slant Case with lock tab construction. E-Flute corrugated board. Ships flat on skids.

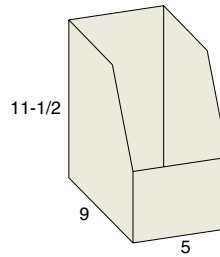

M-2085
5" Corrugated Slant Case with lock tab construction. E-Flute corrugated board. Ships flat on skids.

Film lamination is recommended on all corrugated projects, particularly those with heavy ink coverage in order to prevent cracking. In the event clients choose to proceed without lamination, the plant will not be held responsible for cracking that occurs on non-laminated jobs.

CD/DVD PACKAGING

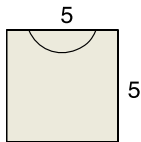

M-600
5 x 5 Single CD Sleeve.

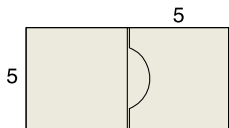

M-601
5 x 5 Single CD Sleeve with flap.

M-602
5 x 5 Single CD Sleeve with reinforced panel.

M-603
5 x 5 Double CD Sleeve.

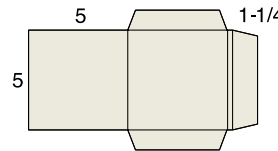

M-605
5 x 5 Economy CD Mailer #1.

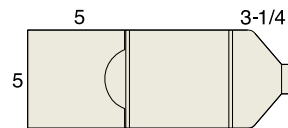

M-606
5 x 5 Economy CD Mailer with #2 Tuck closure.

M-607
5 x 5 Single CD Mailer with reinforced panel with Tuck closure

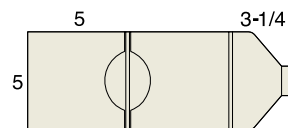

M-608
5 x 5 Double CD Mailer Tuck closure.

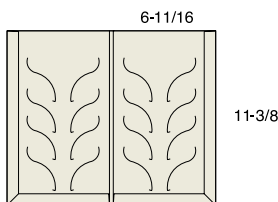

M-604
6-11/16 x 11-3/8 CD Library (holds 4, 6 or 8 CD's)

Our time tested Expander Products work hard to provide increased flexibility to special projects requiring additional capacity. These products are proven to be extremely versatile, durable and add increased value to your project.

The functionality of our Expander products allow for functional expansion while maintaining a clean and neat appearance. Our folders can easily hold up to 100 sheets of paper. Match a folder with one of our mailers for a complete presentation package. There are no additional costs for Expander products. Samples and custom sizes are available.

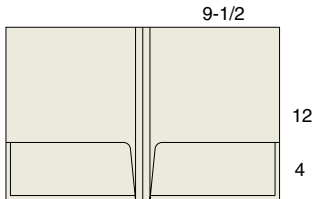

X-900

9-1/2 x 12
Expandable Folder with (2) 4" glued pockets (Same price as M-100, see page 8).

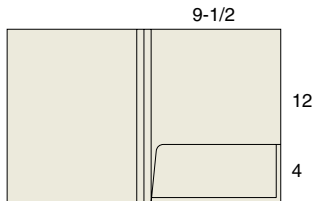

X-903

9-1/2 x 12
Expandable Folder with (1) 4" right glued pocket (Same price as M-100, see page 8).

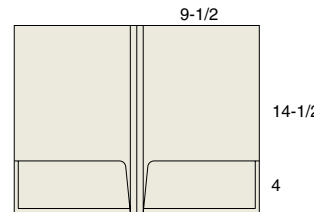

X-905

9-1/2 x 14-1/2
Expandable Legal folder with (2) 4" glued pockets (Same price as M-116, see page 14).

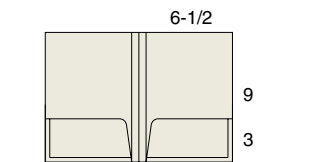

X-909

6-1/2 x 9
Expandable Mid-size folder with (2) 3" glued pockets (Same price as M-119, see page 13).

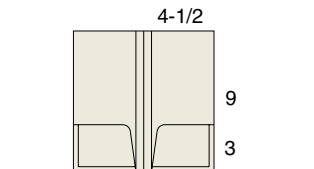

X-910

4-1/2 x 9
Expandable Mini folder with (2) 3" glued pockets (Same price as M-121, see page 13).

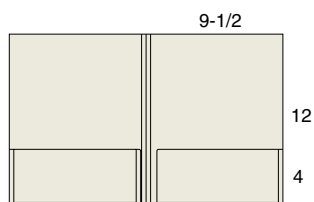

X-915

9-1/2 x 12
Expandable Folder with (1) 4" left glued pocket and (1) 4" right pocket glued both sides.

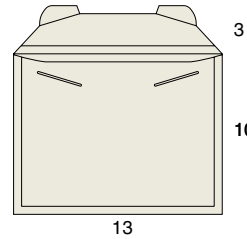

X-901

10 x 13
Expandable Mailer with 3" flap and tuck closure (5/8" Capacity).

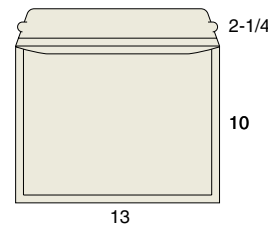

X-902

10 x 13
Expandable Mailer with 2-1/4" flap with nylon tear strip (5/8" Capacity).

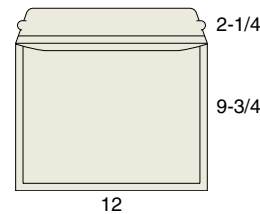

X-916

9-3/4 x 12
Expandable Mailer with 2-1/4" flap with nylon tear strip (5/8" Capacity).

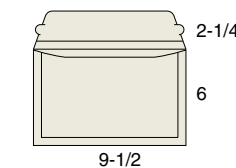

X-917

9-1/2 x 6
Expandable Mailer with 2-1/4" flap with nylon tear strip (1/2" Capacity).

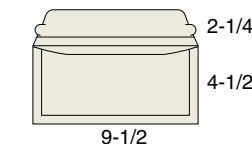

X-918

4-1/2 x 9-1/2
Expandable Mailer with 2-1/4" flap with nylon tear strip (3/8" Capacity).

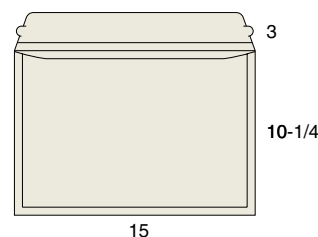

X-919

10-1/4 x 15
Expandable Mailer with 3" flap with nylon tear strip (5/8" Capacity).

CUSTOM PACKAGING

IF YOU DREAM IT, WE CAN MAKE IT.

We design and manufacture a broad range of products that can bring a unique and lasting impact to your communication programs. Our custom packaging line-up can add impact, organization and performance. Our ability to custom design products to meet your most specified needs and store your most important products, provides you with an unlimited variety of creative solutions.

Our design and product development group will work with you every step of the way, helping you select the products that best meet your customer's creative and budget objectives. Because we utilize a CAD system, we can provide prototypes, enabling you to plan each project with greater precision.

As a leading innovator in the art of packaging, we are committed to excellence in every product we make. With all of our manufacturing resources in house, we maintain the highest standards of quality control, delivering every product with single-source reliability and convenience.



Example of a CAD Concept to 3-Dimensional Prototype



BETTER BEGINNINGS DESERVE BETTER FINISHINGS.

Foil Stamping, Embossing, Spot UV, Soft Touch Aqueous, Die Cutting... A lost art? Not at all! We combine the craftsmanship and knowledge of our artisans with today's technology to produce some of the most stunning foil and embossing effects. Need help or suggestions on ways to enhance your next project? We're here to help you.

When your project calls for a custom die cut, we can help there too. Our engineering department can provide you with prototypes and electronic templates to help visualize the end product. Our most popular finishing options include:

- Foil Stamping
- Embossing/Debossing
- Custom Die-Cutting
- Spot/Overall UV Coating
- Gloss Varnish
- Dull Varnish
- Strike-Through
- Soft-Touch
- Aqueous Coating
- Gloss Lamination
- Matte Lamination
- PMS Colors



ENVISION YOUR OWN SUCCESS STORY TODAY!
CONTACT YOUR SALES REP FOR PRICING or **CALL 630.825.1200**
and speak with our packaging solutions team.



YOUR FULL SERVICE COMMUNICATION PROVIDER



MARKETING



PRINTING



PACKAGING



MAILING

ENVISION³

 630-825-1200  INFO@ENVISION-3.COM

 WWW.ENVISION-3.COM